



QEMU Overview

Edgar E. Iglesias

Principal Software Engineer

April/19/2022



Agenda Title

- ▶ QEMU Overview
- ▶ Co-simulation / Hybrid
- ▶ Plans
- ▶ Demos

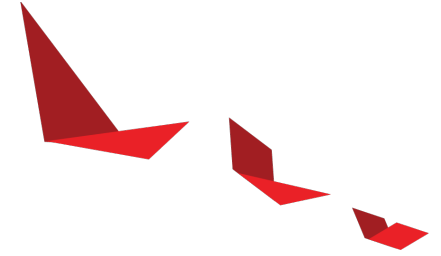



Virtual Platform for SW developers

- Open-Source **Scalable distribution & cost model**, Popular in Open-Source community
- @Xilinx from 2009 MicroBlaze, Power PC, **ARM (Zynq, Zynq MPSoC, Versal)**, x86
- Transaction level Fast but not cycle accurate, Linux boot **2sec to user-space, 2min to prompt**
- Debug & Profiling GDB/XSDB, traces, code-coverage and error-injection (-ve testing)
- Co-simulation SystemC/TLM-2, RTL and Hybrid
- Value Shift left (early SW development), Cost, Speed and Flexibility

Users

- Internal BootROM, System Software, SVT
- External Petalinux, Vitis HW-Emulation, GitHub (Roll your own)

Success stories

- Zynq MPSoC Xilinx a significant contributor to ARMv8, MicroBlaze, RegAPI, Reset, Clocks etc
- DARPA/POSH Xilinx chosen for Open-Source QEMU Co-simulation efforts
- Customers/Vendors X (PetaLinux), Y (Github) and Z (Vitis)

QEMU modes

System Emulation

- Emulation of full system (TCG)
 - Including Virtualization & Security, heterogenous cores, TZ, IOMMU's, XMPU's, PMU, PMC etc
 - DTB machines

Hypervisor KVM

- HW accelerated virtualization
- ZU+, Generic ARM virtual board
- x86 + PCIe co-simulation

Linux-user

- Cross-run Linux binaries (e.g ARM Linux binary on x86 Linux host)
- GCC test-suite, Cross-compilation, Rootfs testing

Done or mostly done

In progress

Planned but not Started

Not Planned

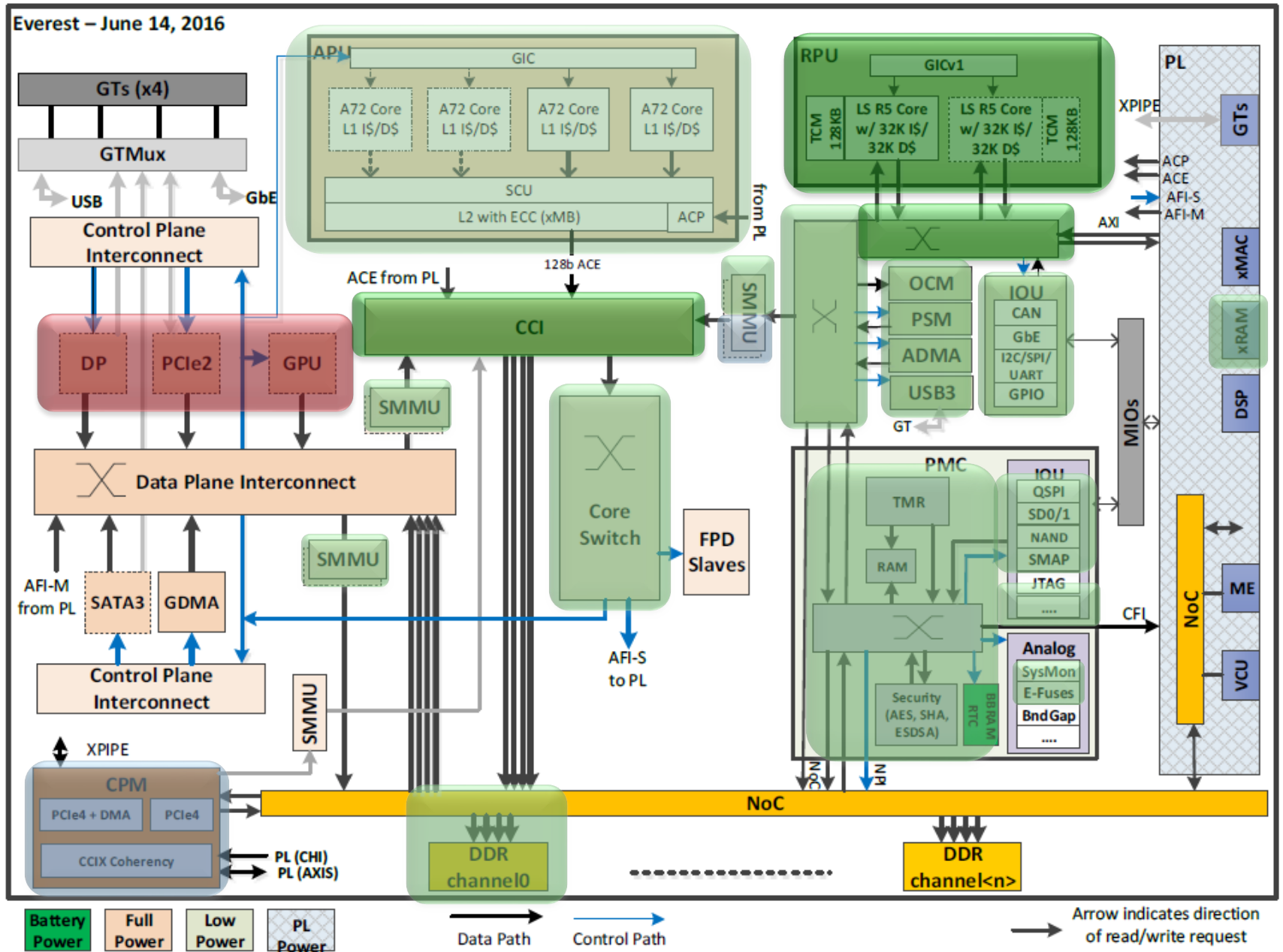

PMC

- Done or mostly done
- In progress
- Planned but not Started
- Not Planned
- Internal Only

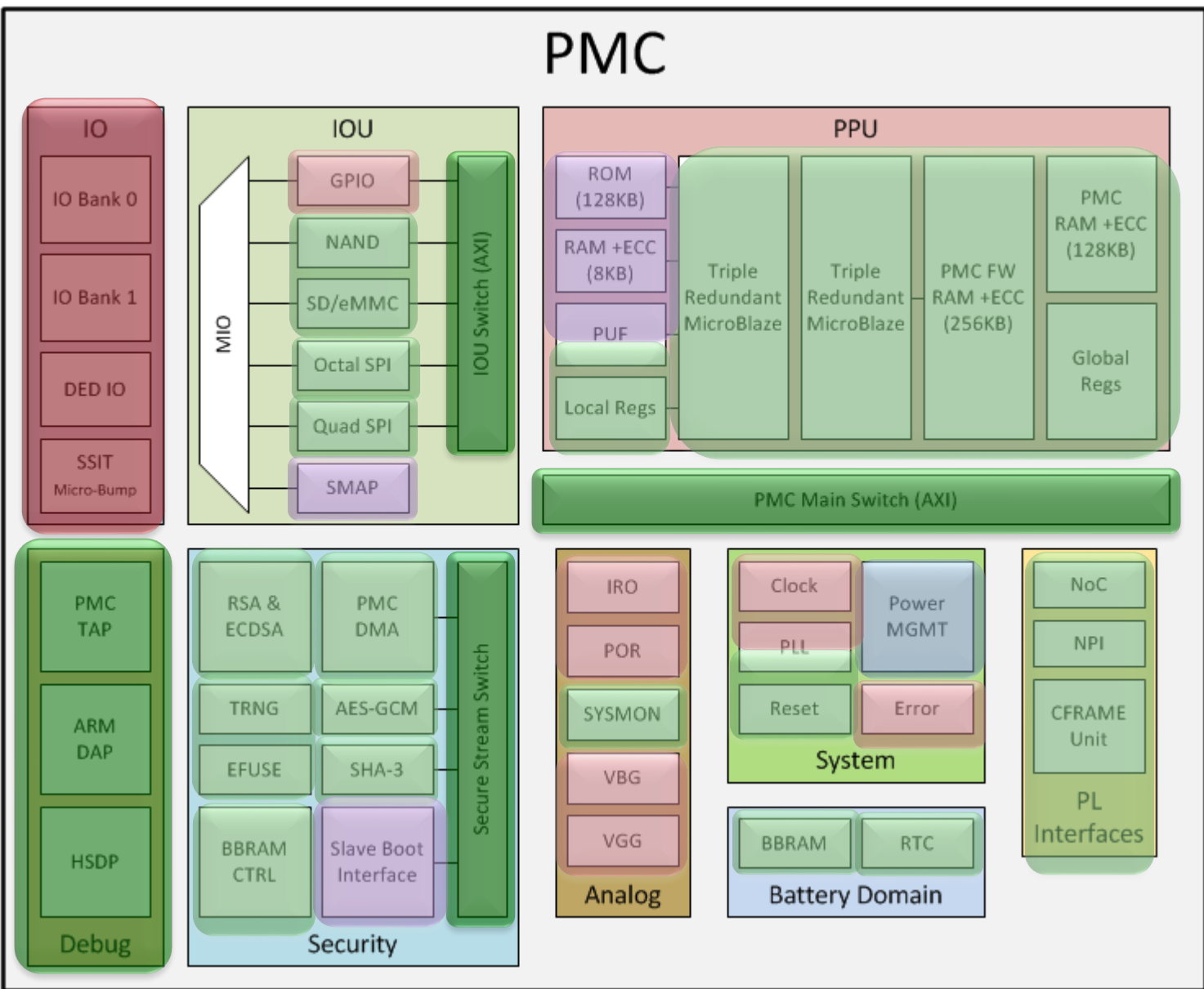

- PUF HW model internal only
- PUF Firmware model public
- SBI depends on BootROM (internal-only)

QEMU System Emulation

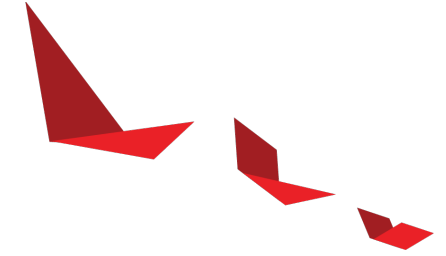

Boot

- Full boot through BootROM (internal only)
- FSBL, U-boot & Linux direct boots

Security

- CSU, PMC-Secure, crypto blocks, EL3/TZ
- Secure-boot depends on BootROM images (internal)

QEMU System Emulation

Debuggers

- GDB
- XSDB (PetaLinux, Vitis and Vivado)

Testing

- QTX - Pytest based test-suite – 500 cases
- TBM – Baremetal test and exploration environment
- PetaLinux 500+ testcases, Vitis 500+ co-simulation test-cases

Tools

- Etrace - tracing and code coverage
- Xregdb, irqmap-gen, memmap-gen – Machine and model skeleton/generation

Co-simulation / Hybrid

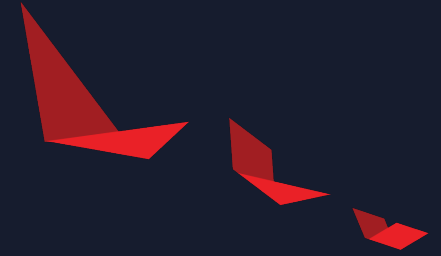

Open Source Mixed Simulation Environment

LibSystemCTLM-SoC

<https://github.com/Xilinx/libsystemctlm-soc>

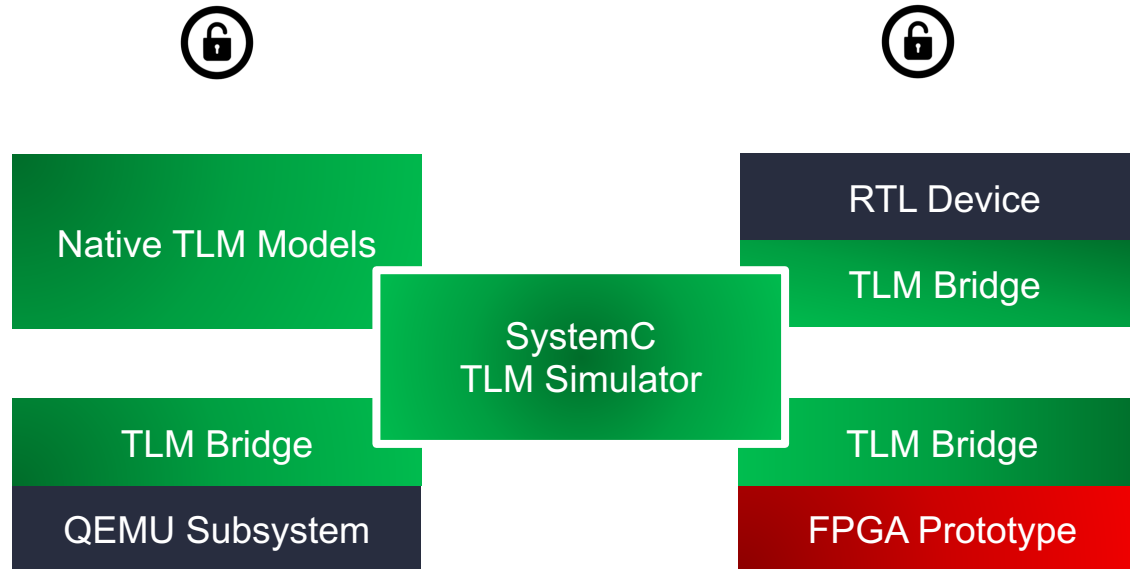

Phase 1a

Phase 1b

Based on Open-Source Projects



Xilinx Vivado/Vitis Co-sim

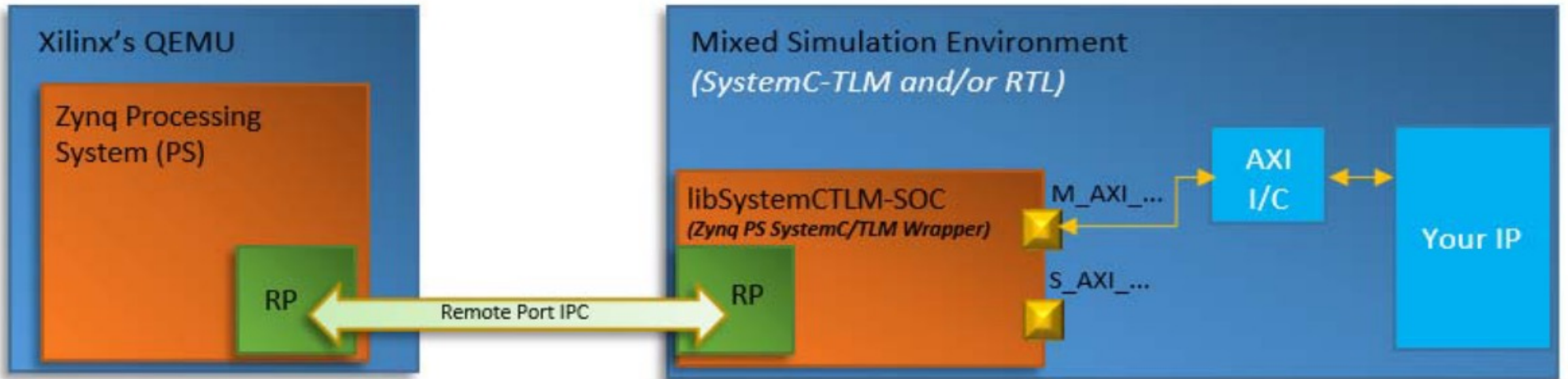

- Unique Process
- Xilinx's Remote Port
- Xilinx's Zynq PS or PS SystemC/TLM Wrapper
- Zynq PS -PL AXI Master/Slave Ports
- Your IP(s)

TLM2 bridges RTL simulation

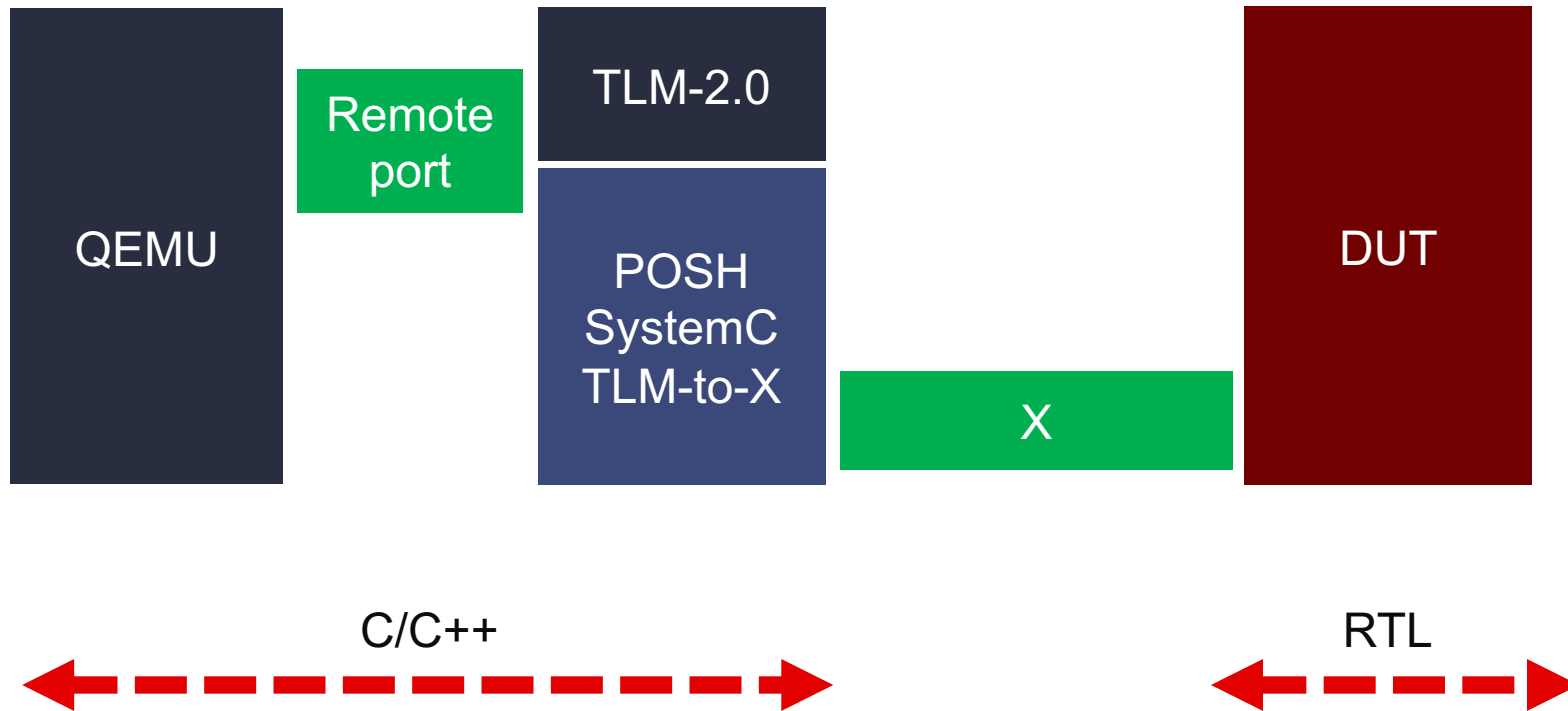

QEMU heterogeneous

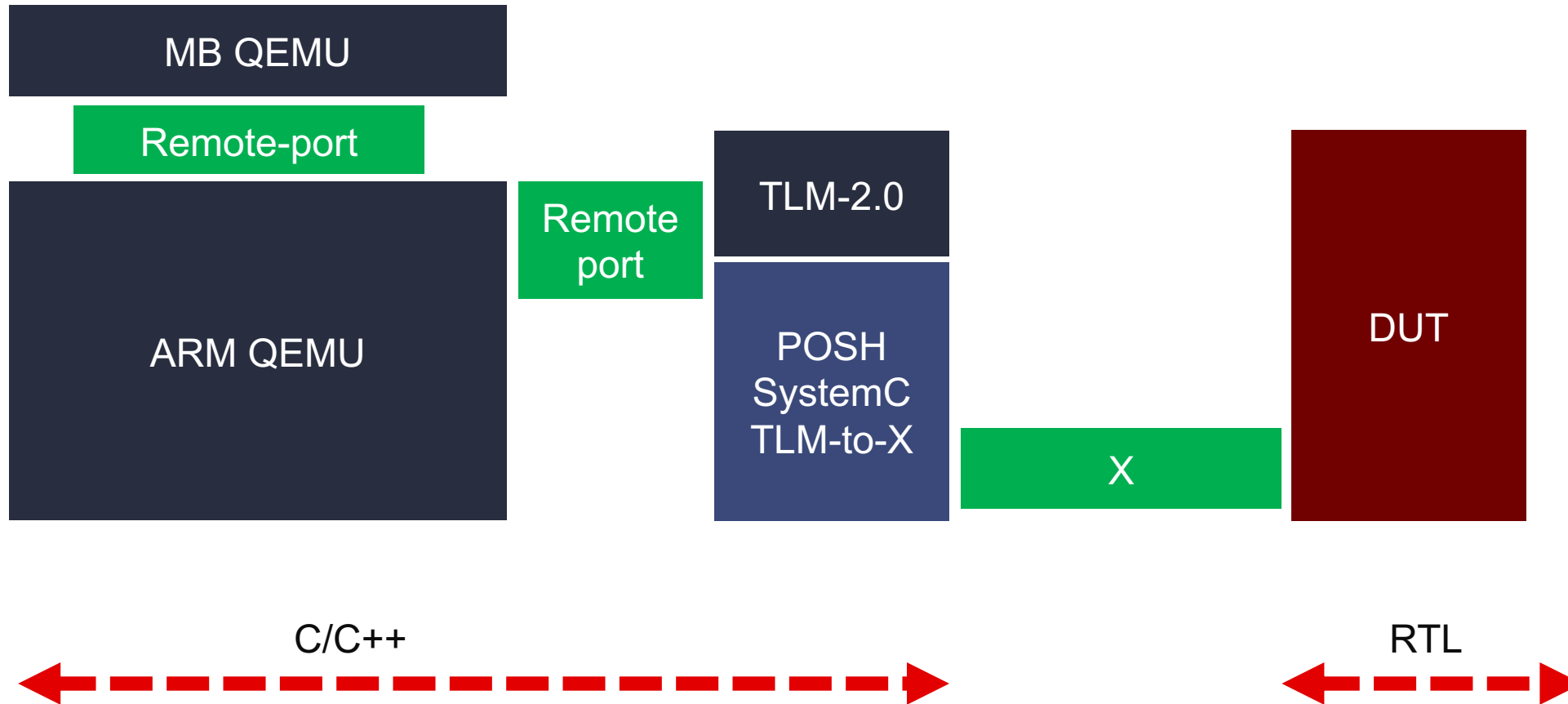

TLM2 bridges FPGA Prototyping

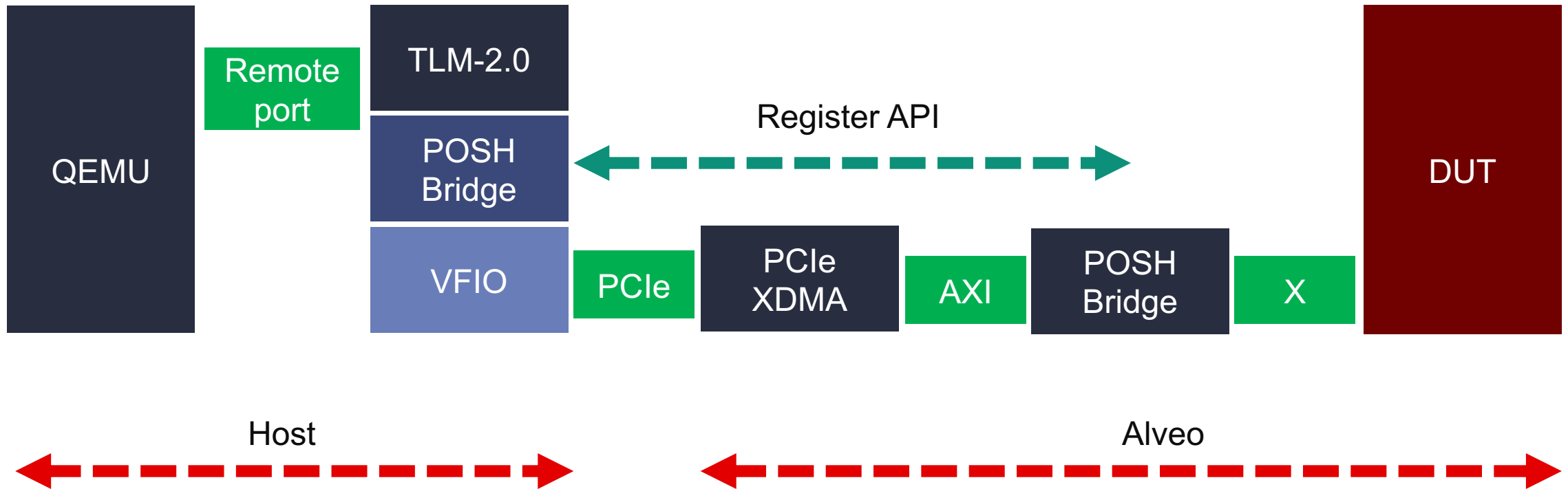

TLM2 bridges Emulator (Initial idea)

Pros: Fast, sort of “Vendor neutral”
Cons: Not debug-portable, Licensing AXI VIP

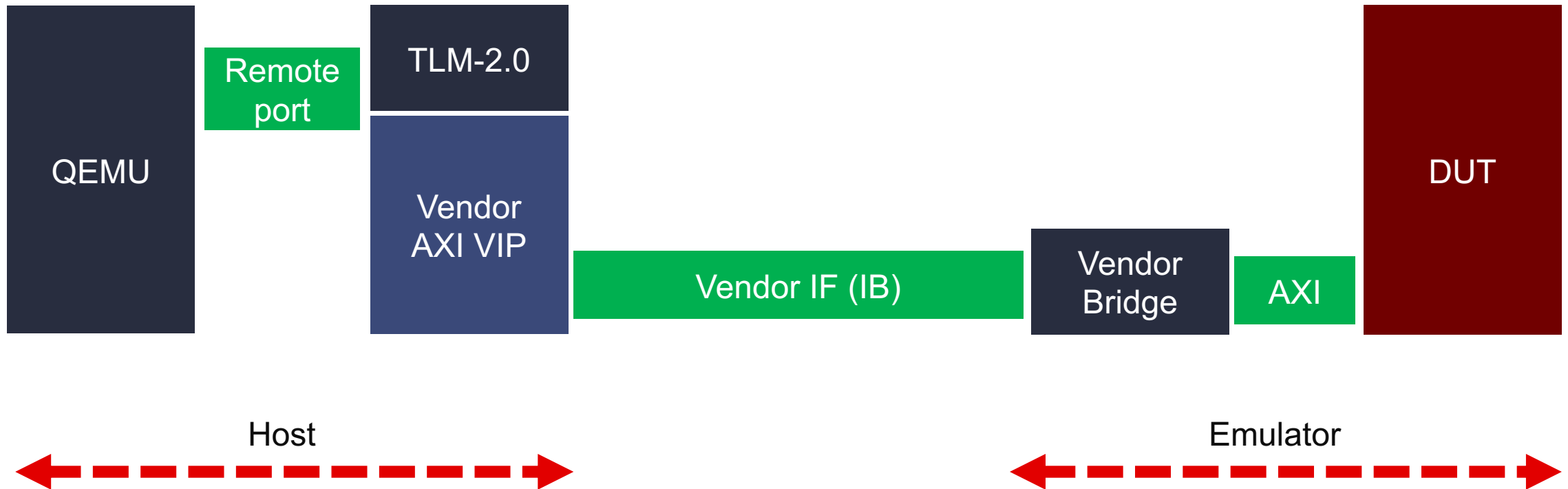

TLM2 bridges Emulator

Pros: Vendor neutral, debug-portable
Cons: Slow, Licensing AXI VIP

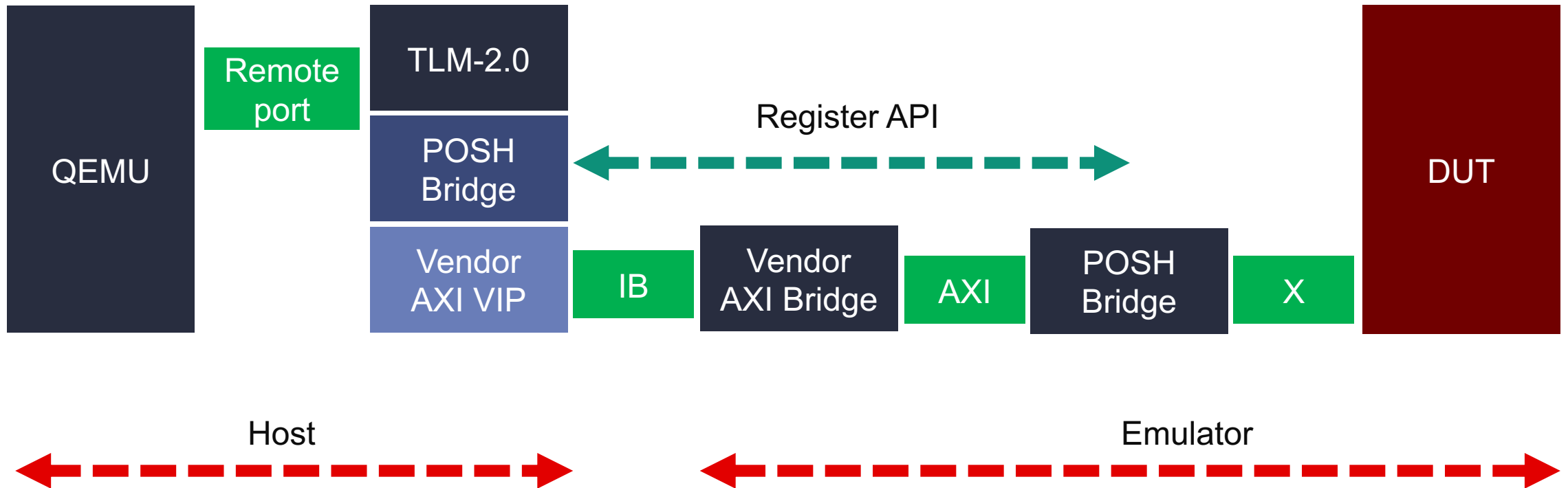



Plans around QEMU upstream

Upstream

Heterogenous
CPUs
Done

Heterogenous
CPUs
Needed

CPUs	MicroBlaze	ARMv8 (EL2, EL3)	PPC 440 BookE	MIPS (R32 SMP, SMT), CRIS	MTTCG, Per CPU AS	CPU Clusters, GDB Multi-process	Heterogenous CPU build and instance support (submitted)
Interrupt controllers	Xilinx Intc	GICv2 (Virt), ZynqMP IPI	PPC Xlnx Intc	EtraxFS PIC		Multiple GICs	
Peripherals	Xilinx UARTs, Cadence UART, DMA, Display	SPI, QSPI, Octal SPI, m25p80, NAND	SDHCI, eMMC, AHCI Sysbus	USB Sysbus, ZynqMP, Versal	Ethernet (MACb, Ethlite, AXI eth), EtraxFS, MDIO, PHYs	PMU, PMC, PSM devices	
Frameworks	Register API	Clock API	Reset API	Named GPIOs/Interrupts	Streaming API	Generic CPU reset & halt (GPIO based)	
Machines	Zynq, ZynqMP, Versal, PetaLinux MB, Virtex ML507 etc	Versal Cortex-A72 + Cortex-R5F CRL (Dynamic wake-up of RPU)	QMP driven machines (ongoing), DTB driven	ZynqMP, Versal Cortex-R5F GIC, IPI connections	PMU, PMC, PSM subsystems		

Programs

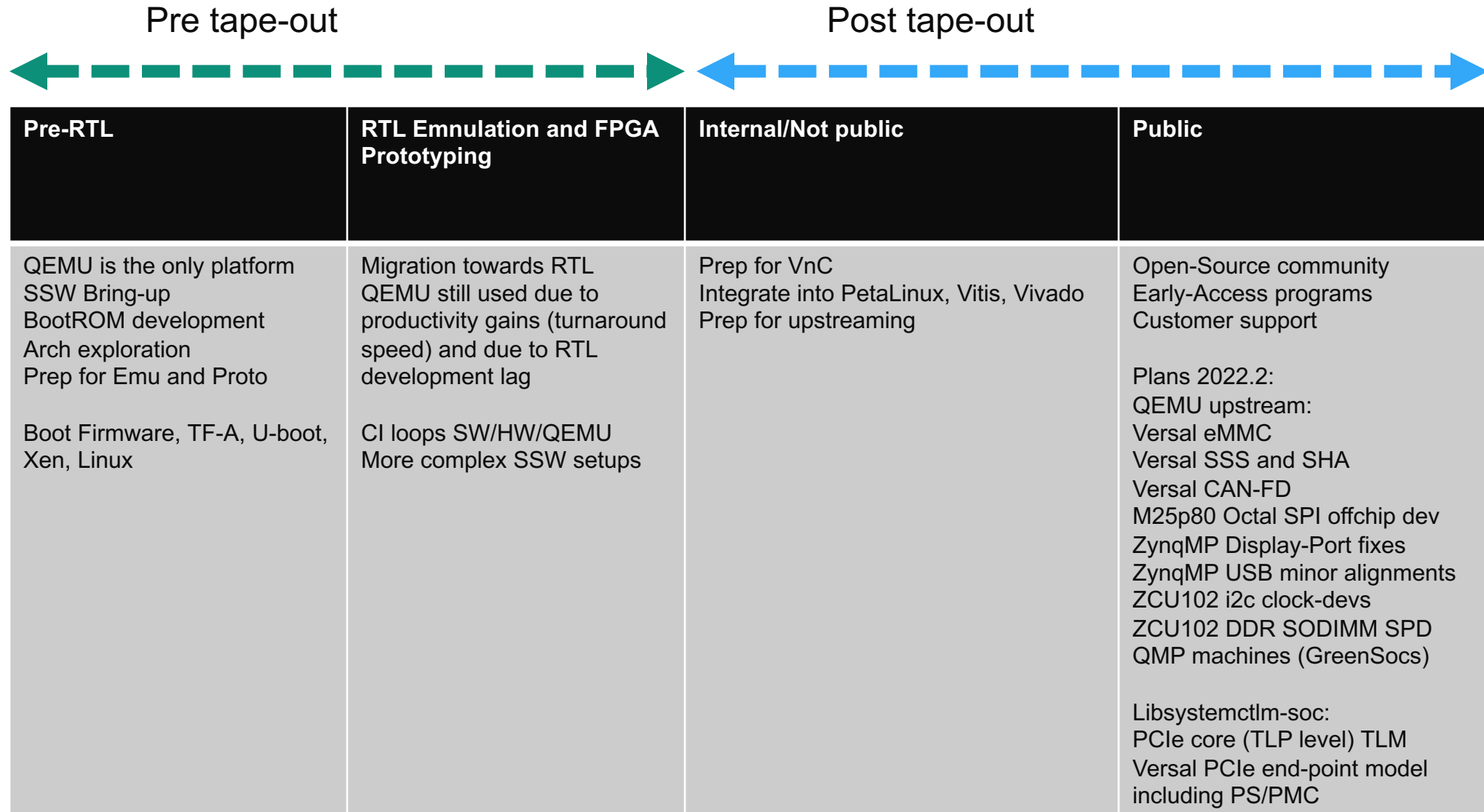

Demo

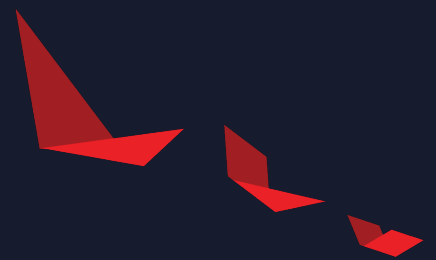

DARPA/POSH

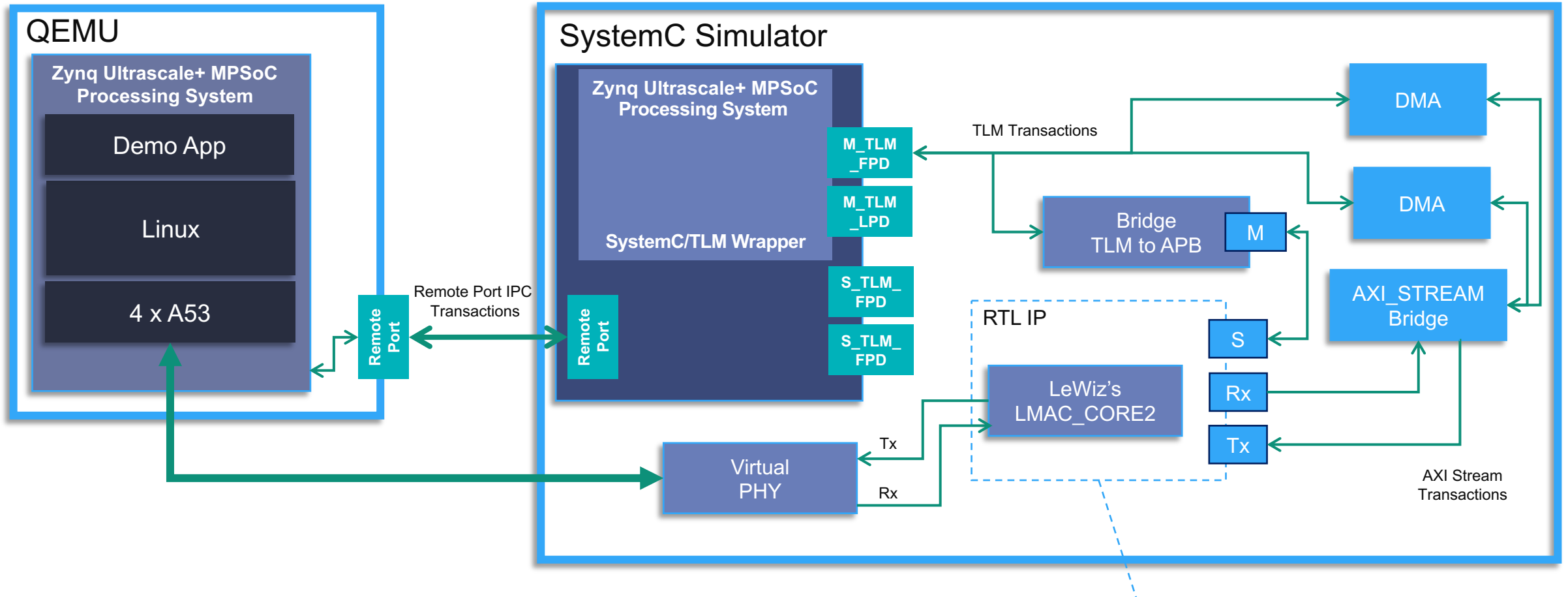

Main Lessons Learnt

- Need Backend connections to the RTL/TLM to feed in real data
- Need for AXI Stream and APB Protocols
- Need to standardize on a particular set of protocols....AXI, Wishbone?
- Successfully identified bug in IP RTL during integration !

LeWiz Communications Ethernet MAC Core2 10G/5G/2.5G/1G



https://github.com/lewiz-support/LMAC_CORE2



Thank You

